

Note that all unique customer requirements (i.e tolerance) need to be verified thru Alfa Laval.

Z 25
Carbon Steel
S1,S2,S3,S4

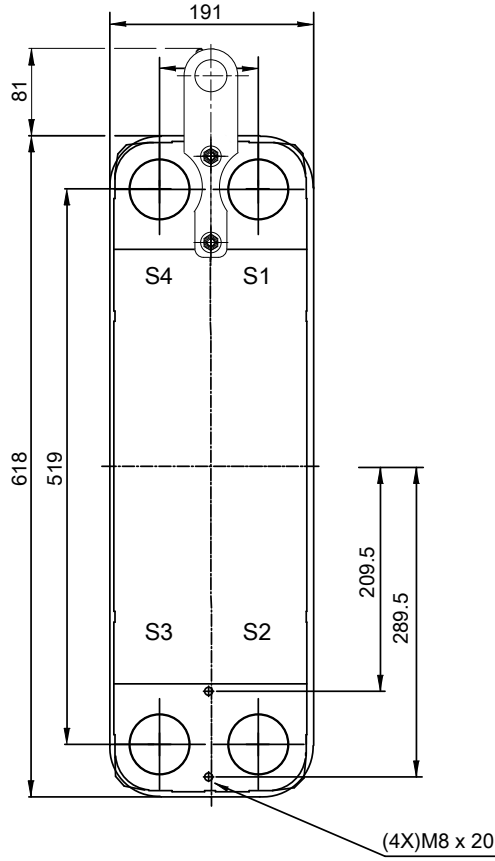
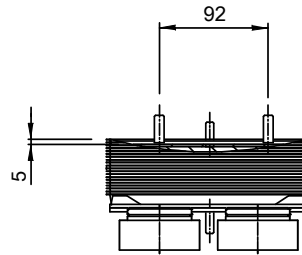
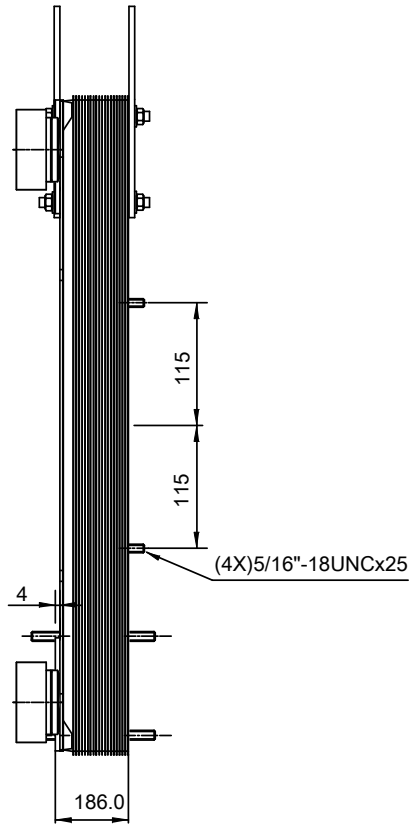
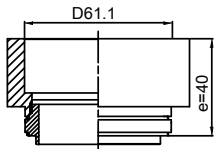

T1 T2 T3 T4 locations on back side correspond to S1 S2 S3 S4 on front side

HEATING SURFACE
NETWEIGHT 45.6 kg
OPERATING WEIGHT
PLATE MATERIAL Alloy 316
PLATE GROUPING 1*29H/1*30H

ALL DIMENSIONS IN MILLIMETERS

SIDE	MEDIA	INLET	TEMP.	OUTLET	TEMP.	FLOW RATE	PRESSURE DROP	LIQUID VOL.
1								7.25 dm ³
2								7.5 dm ³

PRESSURE VESSEL APPROVAL

ASME 302 degr F/CRN

AlfaNova HP 76-60H W66 ASME (3287132653)

www.alfalaval.com

CUSTOMER NAME / REF. NO.

TOTAL LENGTH 247.4 mm
TOTAL WIDTH 191.0 mm
TOTAL HEIGHT 699.0 mm

COMPANY / REF.

6/27/2017
REV 0